

Data Sheet



Article number: 604132036085

Description: Taper bored timing belt pulley
HTD 36 8M 85 TL 1615

Measures

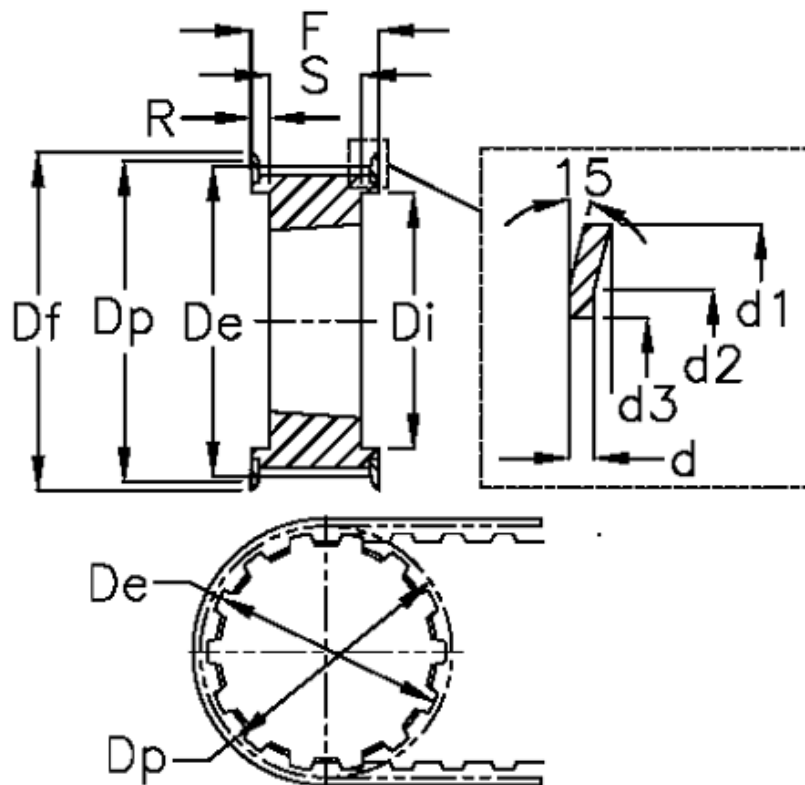

d = 1.5	F = 95	Weight = 1.87
d1 = 97	Flange type = F33	Width = 85
d2 = 93.8	For bushing = 1615	
d3 = 83	Max bore = 42	
De = 90.3	r = 28.5	
Df = 97	S = 38	
Di = 68	Tooth number = 36	
Dp = 91.67	Type = 8M	